

CODE	NAME	DN
2100.113	Rainhead Overflow Sump 530x350x240	150/ 100

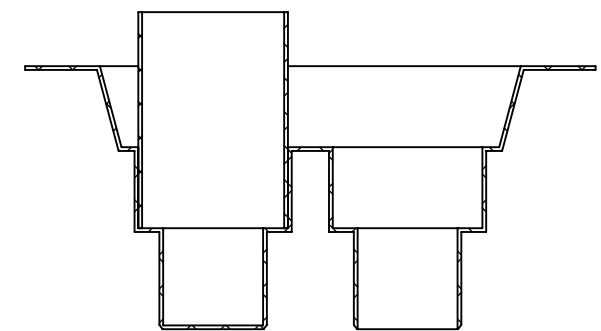
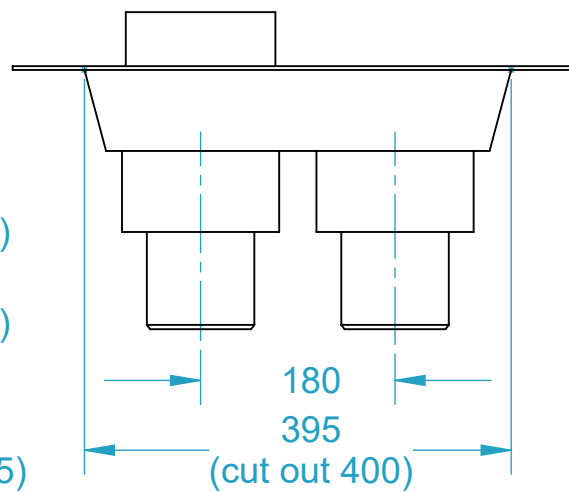
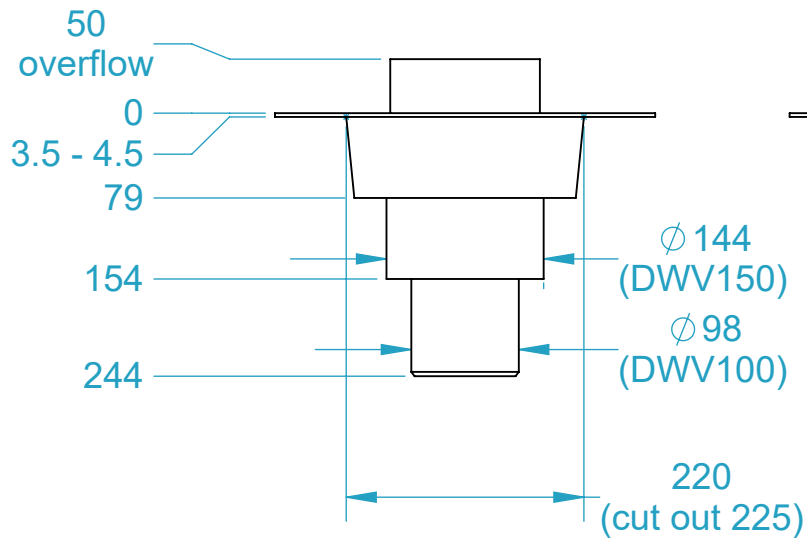
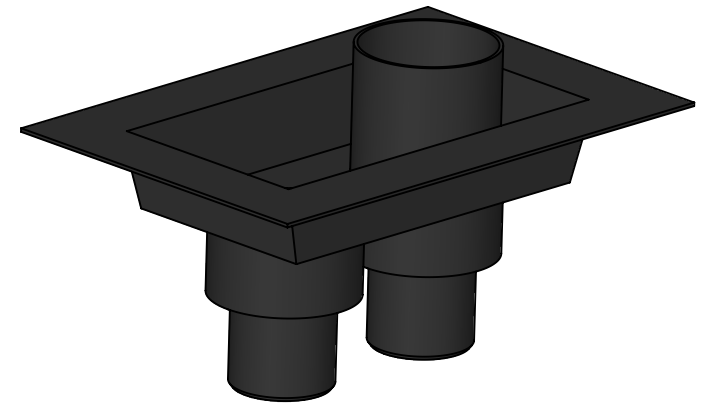
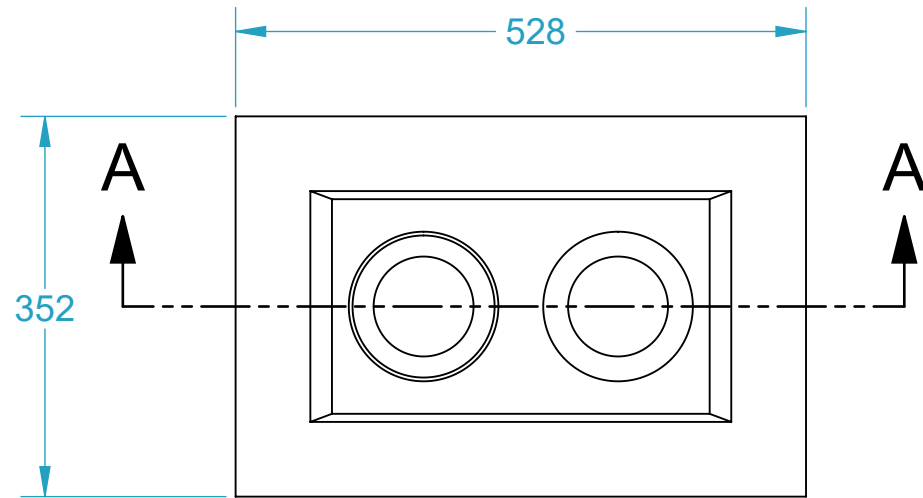

SECTION A-A