

CODE	NAME	DN
2100.103	Scupper Chamfer 100x65x350x 2deg	80

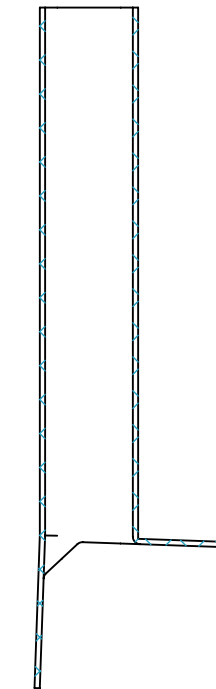

SECTION A-A

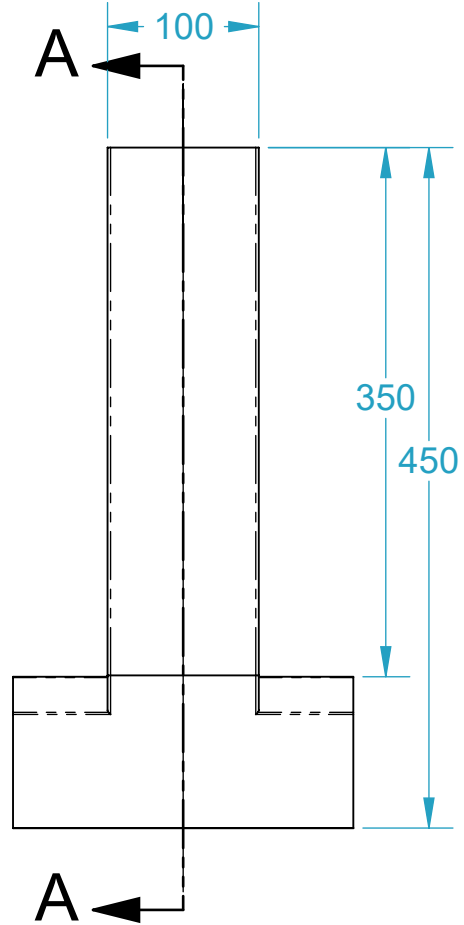
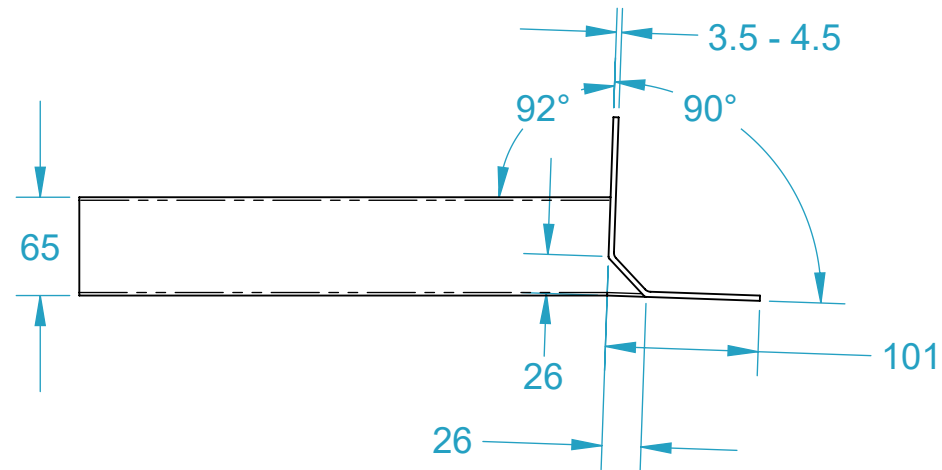
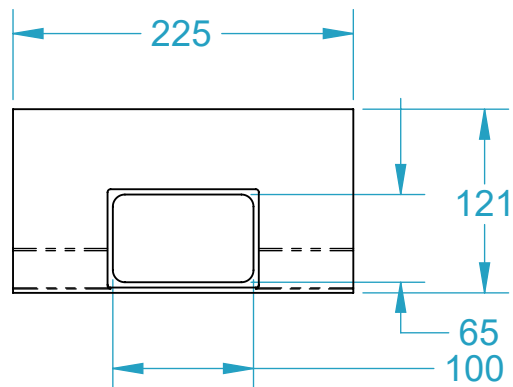