

HiFlow

Leak Return Port Body

Bottom Exit 50mm

Specifications



Flow rate 33-44 l/min
 Water seal None
 Inlet size 90mm
 Outlet size 50mm
 (Solvent welds over 50mm DWV pipe compliant with AS/NZS1260)

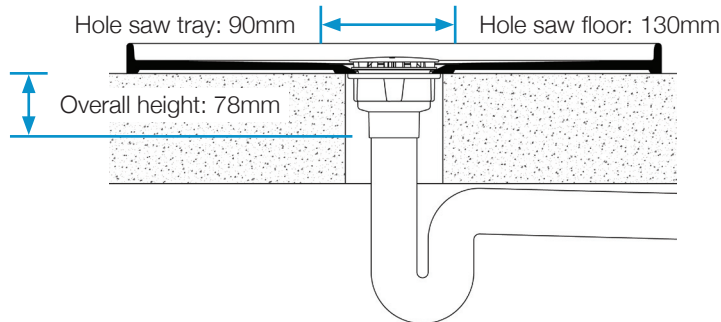

Product Codes



With Flat Lid

	White	LRP FW HF BE50	0526.01
	Ivory	LRP FI HF BE50	0526.02
	Chrome	LRP FC HF BE50	0526.03
	Gold	LRP FG HF BE50	0526.04
	Matt Chrome	LRP FMC HF BE50	0526.05



With Dome Lid

	White	LRP DW HF BE50	0526.11
	Ivory	LRP DI HF BE50	0526.12
	Chrome	LRP DC HF BE50	0526.13
	Gold	LRP DG HF BE50	0526.14
	Matt Chrome	LRP DMC HF BE50	0526.15

Spare Parts Codes

All spare parts are NON-RETURNABLE, please ensure that correct part has been ordered

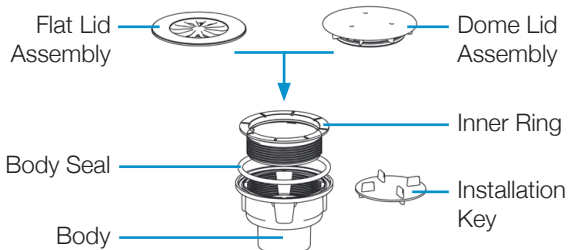

Lid Assembly HiFlow Flat White	0580.01
Lid Assembly HiFlow Flat Ivory	0580.02
Lid Assembly HiFlow Flat Chrome	0580.03
Lid Assembly HiFlow Flat Gold	0580.04
Lid Assembly HiFlow Flat Matt Chrome	0580.05
Lid Assembly HiFlow Dome White	0580.11
Lid Assembly HiFlow Dome Ivory	0580.12
Lid Assembly HiFlow Dome Chrome	0580.13
Lid Assembly HiFlow Dome Gold	0580.14
Lid Assembly HiFlow Dome Matt Chrome	0580.15
Inner Ring	0200.226
Body Seal	0200.202
Body LRP BE50	0200.507
Installation Key	0200.229